

DMS Wireless

450-470 MHz H-POL or V-POL

Electrical Data

Frequency:	450-470 MHz
Gain:	9 dBi
VSWR:	<1.5:1
Polarization:	Horizontal or Vertical
Horizontal Beamwidth :	62°
Vertical Beamwidth:	50°
Nominal Impedance:	50 Ohms
F/B Ratio:	> 16 dB
Max Input Power:	100 W
Lightning Protection:	DC Ground

Mechanical Data

Connector :	N Male
Dimensions:	638mm/25.1in
Weight:	2.2kg/4.9lb
Cable Length:	360mm/14.2in
Reflector Material:	Aluminum Alloy
Antenna Material:	Stainless Steel
Mounting Method:	Mast
Mast Size:	Ø40-Ø50mm
Rated Wind Velocity:	210km/h
Operating temperature:	-40~+65°C

Shipment Data

Packing Qty:	5pcs/Carton
Carton Size:	670*390*430mm
(length*width*height)	/26.4*15.4*16.9in
Packing Weight:	13kg/28.6lb

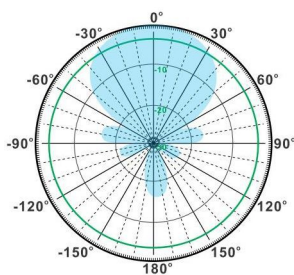

H-Plane

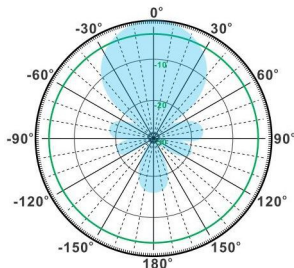

V-Plane

YA450-470-9HV-5EW

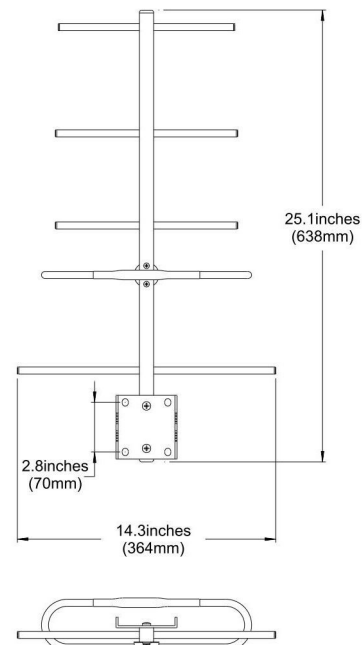

Email: sales@dmswireless.com
www.dmswireless.com

Notice: Specifications are subject to change without notice.
Images may not reflect the actual product.