

DMS Wireless

806-960 MHz 90° V-POL

Electrical Data

Frequency:	806-960 MHz
Gain:	14 dBi
VSWR:	<1.5:1
Polarization:	Vertical
Horizontal Beamwidth :	90°
Vertical Beamwidth:	13°
Nominal Impedance:	50 Ohms
F/B Ratio:	>20 dB
Max Input Power:	250 W
Lightning Protection:	DC Ground

Mechanical Data

Connector :	N Female
Dimensions:	1270*290*130mm
length*width*height	/50.0*11.4*5.1in
Weight:	11.6kg/25.6lb
Reflector Material:	Aluminum Alloy
Radome Material:	UV Resistance PVC
Mounting Method:	Mast
Mast Size:	Ø50-Ø90mm
Rated Wind Velocity:	210km/h
Operating temperature:	-40~+65°C

Shipment Data

Packing Qty:	1pc/Carton
Carton Size:	1670*330*195mm
(length*width*height)	/65.7*13.0*7.7in
Packing Weight:	13.4kg/29.5lb

PA806-960-90-14V

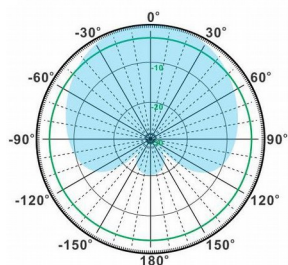

H-Plane

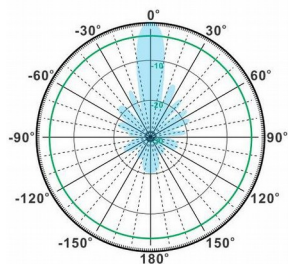

V-Plane

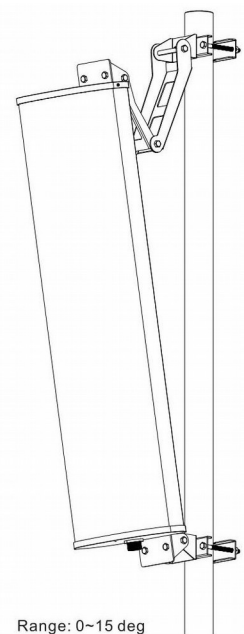
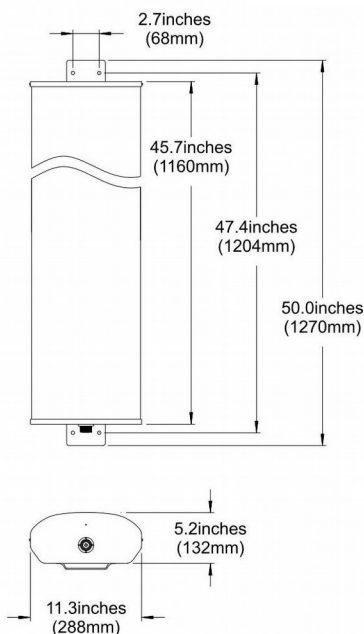

Range: 0~15 deg

Email: sales@dmswireless.com
www.dmswireless.com

Notice: Specifications are subject to change without notice.
Images may not reflect the actual product.