

DMS Wireless

1920-2100 MHz H-Pol or V-Pol

Electrical Data

Frequency:	1920-2100 MHz
Gain:	20 dBi
VSWR:	<1.5:1
Polarization:	Horizontal or Vertical
Horizontal Beamwidth :	9.5°
Vertical Beamwidth:	13°
Nominal Impedance:	50 Ohms
F/B Ratio:	>30
Max Input Power:	100 W
Lightning Protection	DC Ground

Mechanical Data

Connector :	N Female
Dimensions:	900*600*380mm
(diameter*height)	/35.44*23.63*14.96in
Weight:	2.4kg/6.61lb
Reflector Material:	Brass
Mounting Method:	Mast
Mast Size:	Ø30-Ø50mm
Rated Wind Velocity:	210km/h
Operating temperature:	-40~+65°C

Shipment Data

Packing Qty:	5pcs/Carton
Carton Size:	635*565*230mm
(length*width*height)	/25*22.24*9.1in
Packing Weight:	14kg/30.84lb

GA1920-2100-20HV

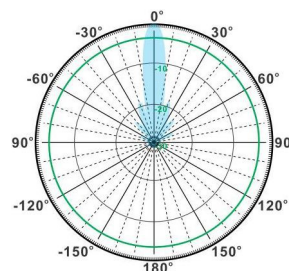
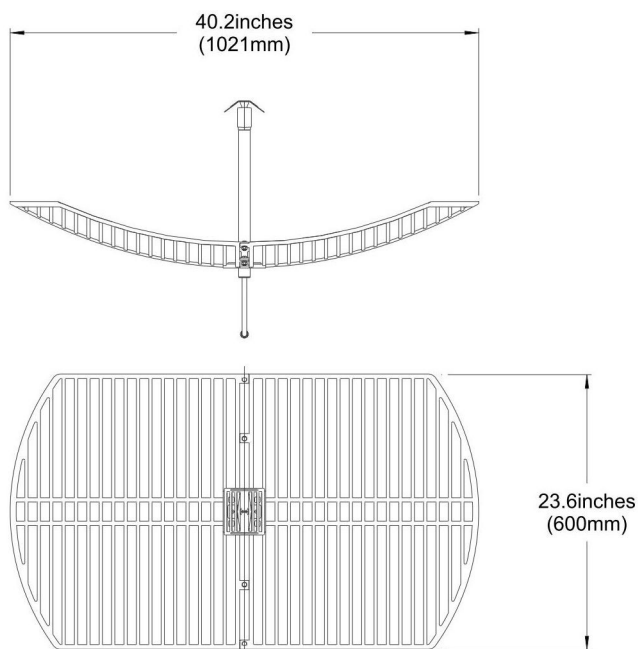

H-Plane

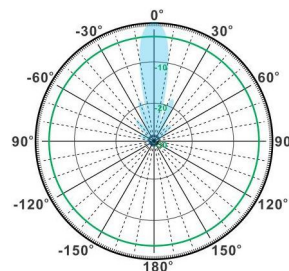

V-Plane

Email: sales@dmswireless.com
www.dmswireless.com

Notice: Specifications are subject to change without notice.
Images may not reflect the actual product.