

DMS Wireless

2500-2686 MHz 90° H-POL

Electrical Data

Frequency:	2500-2686 MHz
Gain:	14 dBi
VSWR:	<1.5:1
Polarization:	Horizontal
Horizontal Beamwidth :	90°
Vertical Beamwidth:	13°
Nominal Impedance:	50 Ohms
F/B Ratio:	>15dB
Max Input Power:	100 W
Lightning Protection:	DC Ground

Mechanical Data

Connector :	N Female
Dimensions:	1040*165*70mm
length*width*height	/41.0*6.5*2.8in
Weight:	3.1kg/6.9lb
Reflector Material:	Aluminum Alloy
Radome Material:	UV Resistance PVC
Mounting Method:	Mast
Mast Size:	Ø40-Ø70mm
Rated Wind Velocity:	210km/h
Operating temperature:	-40~+65°C

Shipment Data

Packing Qty:	1pc/Carton
Carton Size:	1330*200*110mm
(length*width*height)	/52.4*7.9*4.3in
Packing Weight:	4.2kg/9.3lb

PA2500-2686-90-14H

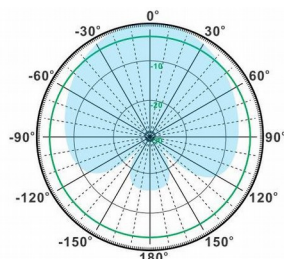

H-Plane

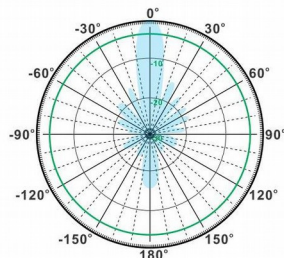

V-Plane

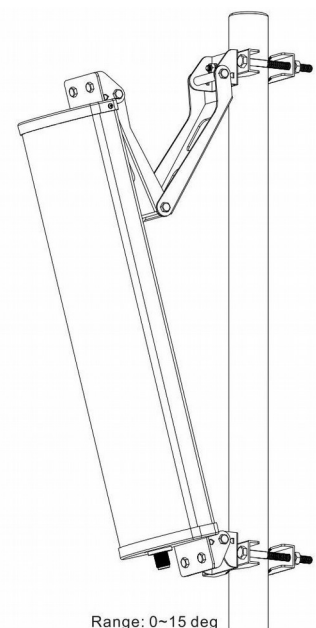
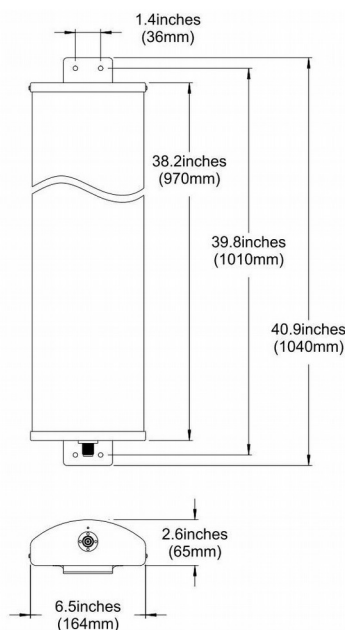

Range: 0~15 deg

Email: sales@dmswireless.com
www.dmswireless.com

Notice: Specifications are subject to change without notice.
 Images may not reflect the actual product.