

DMS Wireless

824-960 MHz H-POL or V-POL

Electrical Data

Frequency:	824-960 MHz
Gain:	7 dBi
VSWR:	<1.5:1
Polarization:	Horizontal or Vertical
Horizontal Beamwidth :	65°
Vertical Beamwidth:	55°
Nominal Impedance:	50 Ohms
F/B Ratio:	>16 dB
Max Input Power:	100 W
Lightning Protection:	DC Ground

Mechanical Data

Connector :	N Female
Dimensions:	510mm/20.1in
Weight:	0.4kg/0.9lb
Cable Length:	360mm/14.2in
Reflector Material:	Aluminum Alloy
Mounting Method:	Mast
Mast Size:	Ø40-Ø50mm
Rated Wind Velocity:	210km/h
Operating temperature:	-40~+65°C

Shipment Data

Packing Qty:	10pcs/Carton
Carton Size:	530*390*325mm
(length*width*height)	/20.9*15.4*12.8in
Packing Weight:	5.2kg/11.5lb

YA824-960-7HV-5E

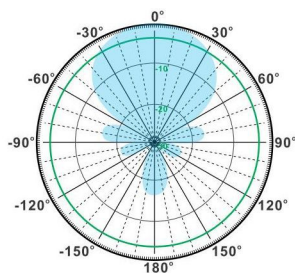

H-Plane

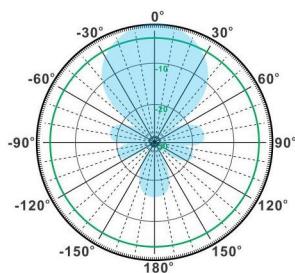

V-Plane

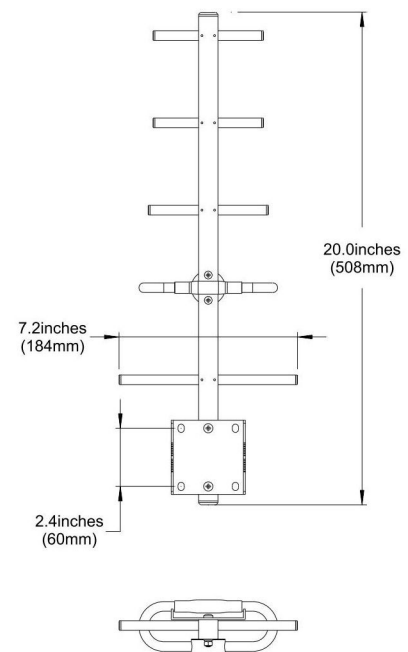

Email: sales@dmswireless.com
www.dmswireless.com

Notice: Specifications are subject to change without notice.
 Images may not reflect the actual product.