

DMS Wireless

2400-2483 MHz H-POL or V-POL

Electrical Data

Frequency:	2400-2483 MHz
Gain:	14 dBi
VSWR:	<1.5:1
Polarization:	Horizontal or Vertical
Horizontal Beamwidth :	31°
Vertical Beamwidth:	29°
Nominal Impedance:	50 Ohms
F/B Ratio:	>16 dB
Max Input Power:	100 W
Lightning Protection:	DC Ground

Mechanical Data

Connector :	N Female
Dimensions:	500mm/19.7in
Weight:	0.4kg/0.8lb
Cable Length:	240mm/9.5in
Reflector Material:	Aluminum Alloy
Mounting Method:	Mast
Mast Size:	Ø40-Ø50mm
Rated Wind Velocity:	210km/h
Operating temperature:	-40~+65°C

Shipment Data

Packing Qty:	20pcs/Carton
Carton Size:	530*375*260mm
(length*width*height)	/20.9*14.8*10.2in
Packing Weight:	8.6kg/18.9lb

YA2400-2483-14HV-11E

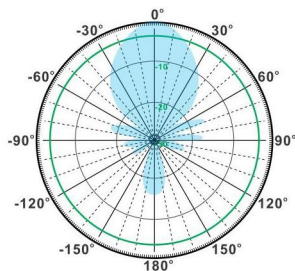

H-Plane

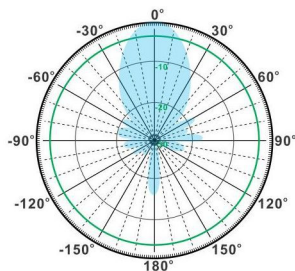

V-Plane

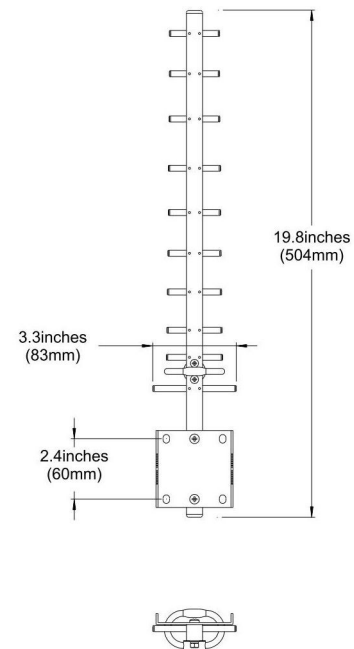

Email: sales@dmswireless.com
www.dmswireless.com

Notice: Specifications are subject to change without notice.
Images may not reflect the actual product.