

DMS Wireless

698-760 MHz H-POL or V-POL

Electrical Data

Frequency:	698-760 MHz
Gain:	9 dBi
VSWR:	<1.5:1
Polarization:	Horizontal or Vertical
Horizontal Beamwidth :	55°
Vertical Beamwidth:	48°
Nominal Impedance:	50 Ohms
F/B Ratio:	>16 dB
Max Input Power:	100 W
Lightning Protection:	DC Ground

Mechanical Data

Connector :	N Female
Dimensions:	430mm/16.9in
Weight:	0.6kg/1.4lb
Cable Length:	360mm/14.2in
Reflector Material:	Aluminum Alloy
Antenna Material:	Mast
Mast Size:	Ø40-Ø50mm
Rated Wind Velocity:	210km/h
Operating temperature:	-40~+65°C

Shipment Data

Packing Qty:	10pcs/Carton
Carton Size:	460*455*315mm
(length*width*height)	/18.1*17.9*12.4in
Packing Weight:	7.3kg/16.1lb

YA698-760-9HV-5E

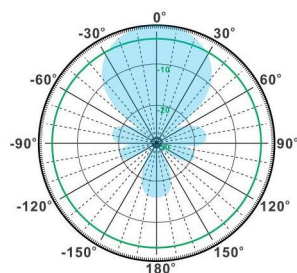

H-Plane

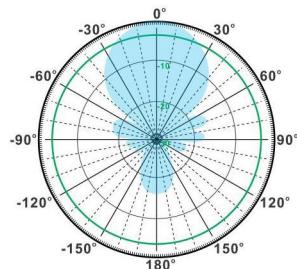

V-Plane

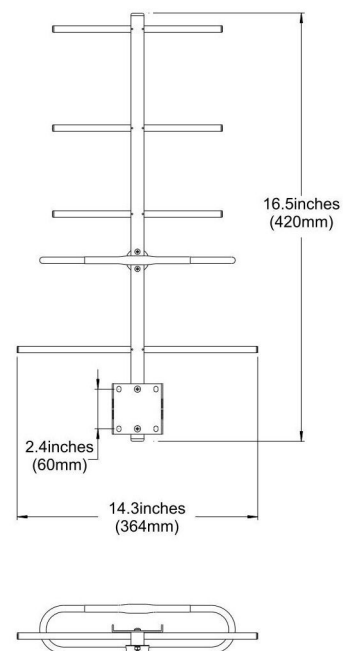

Email: sales@dmswireless.com
www.dmswireless.com

Notice: Specifications are subject to change without notice.
Images may not reflect the actual product.