

DMS Wireless

824-960 MHz H-POL or V-POL

Electrical Data

Frequency:	824-960 MHz
Gain:	6 dBi
VSWR:	<1.5:1
Polarization:	Horizontal or Vertical
Horizontal Beamwidth :	70°
Vertical Beamwidth:	58°
Nominal Impedance:	50 Ohms
F/B Ratio:	>16 dB
Max Input Power:	100 W
Lightning Protection:	DC Ground

Mechanical Data

Connector :	N Female
Dimensions:	435mm/17.1in
Weight:	0.4kg/0.8lb
Cable Length:	360mm/14.2in
Reflector Material:	Aluminum Alloy
Mounting Method:	Mast
Mast Size:	Ø40-Ø50mm
Rated Wind Velocity:	210km/h
Operating temperature:	-40~+65°C

Shipment Data

Packing Qty:	20pcs/Carton
Carton Size:	770*455*325mm
(length*width*height)	/30.3*17.9*12.8in
Packing Weight:	9.6kg/21.1lb

YA824-960-6HV-4E

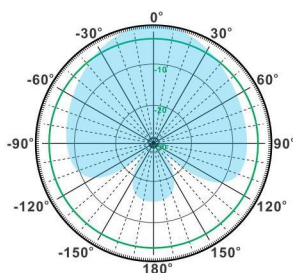

H-Plane

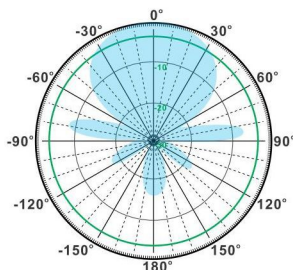

V-Plane

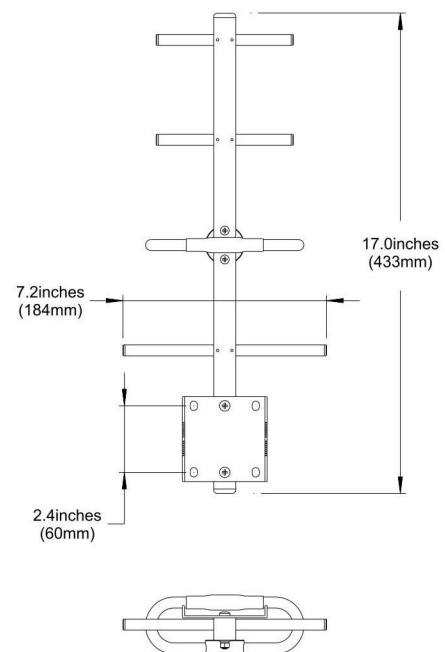

Email: sales@dmswireless.com
www.dmswireless.com

Notice: Specifications are subject to change without notice.
Images may not reflect the actual product.